

PAUL A

Produktinformatie



verwerkte materialen

- ROMP** : Verlijmd massiefhouten romp; Spaanplaat E-1 ; Beaverboard; Multiplex; Stoffeer board;
- ZIT** : Nosagveren; Var. 1 - Schuim 35kg/m3 + Zitmat (Schuim+Dons); Diolenwattenafdeklaag;
Var. 2 - Pocketveren + Schuim 35kg/m3 + Zitmat (Schuim+Dons);
Var. 3 - Tiger Schuim + Zitmat (Schuim+Dons); Diolenwattenafdeklaag;
- RUG** : Standaard Rugkussen -(Schuim+Siliconen); Stegkussen - HR Schuim 30kg/m3 + Rugmat (Schuim+Dons); Rugkussen m.Rastomat - (Schuim+Siliconen);
- POTEN** : Metaal; Hout;

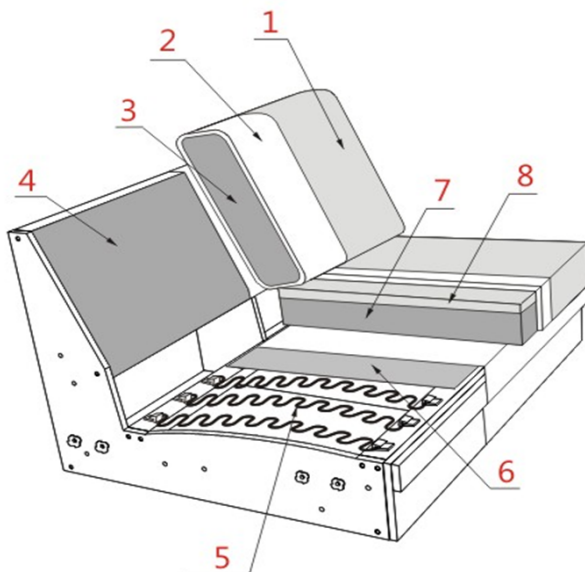

- 1 Stof/Leder
- 2 Diolenwattenafdeklaag
- 3 Rugkussen / Stegkussen
- 4 Beaverboard
- 5 Nosagveren
- 6 Vezelvlies
- 7 V1-VP; V2-TASCHENFEDERKERN; V3-TIGER SCHUIM

PAUL A

Produktinformatie

Alle elementen kunnen één of twee kleurig worden besteld (1: ombouw-arm en zit 2: rug kussen).
Bij mix van twee prijsgroepen bepaalt de hoogste prijsgroep de te betalen prijs.

Contrastnaad

Voor overzicht beschikbare stoffen die met contrastnaad kunnen: zie stof - leder lijst.

Onderstaand de drie beschikbare contrastkleuren:

S10/1003 bruin

S10/415 licht grijs

S10/861 licht beige

Graag de keuze op de order aangeven: kleur en het nummer van de gewenste naad.

Zonder vermelding wordt altijd standaard geleverd (Ton sur Ton).

Zitcomfort soorten:

1. VP/Matte als standaard

2. Pocketverring / Matte als optie tegen meerprijs

3. Tiger / Matte als optie tegen meerprijs

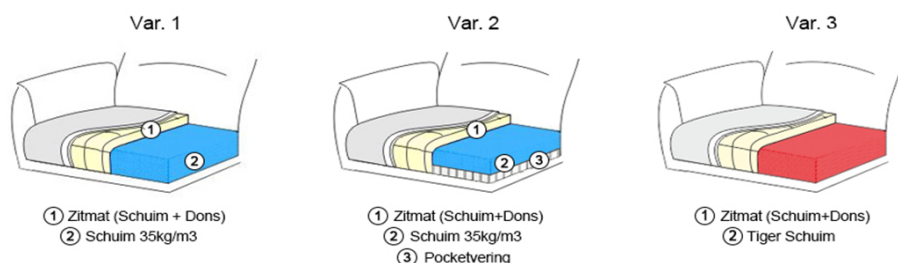

Rugkussen soorten

- Rugkussen als standaard (breedte aangepast aan zitkussenbreedte)
- Rugkussen hoog als optie **tegen meerprijs** (breedte alleen ca 75 cm)
- Rugkussen m. Rastomat als optie **tegen meerprijs** (breedte alleen ca 75 cm)

rugkussen standaard
gelijk aan zitbreedte



rugkussen hoog
breedte 75cm



rugkussen hoog
breedte 75cm met rastomat



Let op! Binnen een element moeten de rugkussens hetzelfde zijn.

De kussens en rugkussen m. rastomat kunnen ook apart worden besteld.

2 Zitdiepte

In het model zijn er 2 dieptes van de elementen: diepte 104 cm (ondiep)

diepte 120 cm (diep)

Let op bij het bestellen:

dat elementen met verschillende diepten niet kunnen worden verbonden!

Poten

- Houten poten (HF) als standaard
 - Metalen poten (Reling) als optie tegen meerprijs
- Metalen poten (Reling) verkrijgbaar in de kleuren: zwart en chroom
Voor beschikbare houtskleuren: zie houtstalen bundel DFM



HF1 h- 4 cm
HF2 h- 6 cm

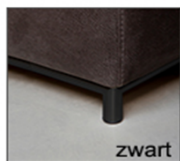

Reling 1 h- 4 cm
Reling 2 h- 6 cm

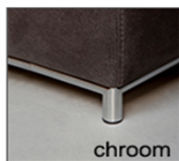

Reling 1 h- 4 cm
Reling 2 h- 6 cm

Twee zithoogtes

Zithoogte 43 cm; poten HF1, Reling 1 (poothoogte 4 cm) als standaard
Zithoogte 45 cm; poten HF2, Reling 2 (poothoogte 6 cm)

Bij dit model zijn de poten voorgemonteerd.

Bij dit model wordt een krokodillenbeksysteem gebruikt om de elementen te koppelen.
Sierkussens, lendenkussens en hoofdsteunen zijn los te bestellen.

Let op!

De pictogrammen zijn voor verduidelijking en niet exact gelijk aan de werkelijke uitvoering.
Bij de aangegeven maten kunnen afwijkingen ontstaan (+/- 5cm).
Bij het samenstellen van de modellen; noteren van links naar rechts (voorstaand).

A = 27 cm
B = 43 cm; h-4cm
C = 59 cm / 74 cm
H = 79 cm; h-4 cm
L = 104 cm / 120 cm

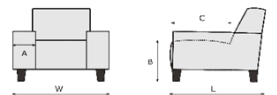

NL PRIJSLIJST PAUL A							
Artikel code	1500U 1,5 UNTIEF	1500 1,5 TIEF	1501U 1,5AL UNTIEF	1503U 1,5AR UNTIEF	1501 1,5AL TIEF	1503 1,5AR TIEF	
OMSCHRIJVING	1,5 zits zonder armen, ondiep	1,5 zits zonder armen, diep	1,5 zits met arm links, ondiep	1,5 zits met arm rechts, ondiep	1,5 zits met arm links, diep	1,5 zits met arm rechts, diep	
BREEDTE (W)	100 cm	100 cm	127 cm	127 cm	127 cm	127 cm	
DIEPTE (L)	104 cm	120 cm	104 cm	104 cm	120 cm	120 cm	
HOOGTE (H)	79 cm	79 cm	79 cm	79 cm	79 cm	79 cm	
ZITHOOGTE (B) & ZITDIEPTE (C)	43 cm & 59 cm	43 cm & 74 cm	43 cm & 59 cm	43 cm & 59 cm	43 cm & 74 cm	43 cm & 74 cm	
QBM	0.67 qbm	0.77 qbm	0.85 qbm	0.85 qbm	0.98 qbm	0.98 qbm	
Stof	EUR	EUR	EUR	EUR	EUR	EUR	
2	491	526	592	592	627	627	
3	506	541	612	612	647	647	
4	539	576	651	651	691	691	
5	561	603	680	680	717	717	
6	576	618	700	700	739	739	
7	616	660	748	748	790	790	
8	656	706	801	801	845	845	
9	711	763	865	865	911	911	
Leer	EUR	EUR	EUR	EUR	EUR	EUR	
W1	794	845	972	972	1.032	1.032	
W2	823	876	1.008	1.008	1.069	1.069	
WM/W9/W12/RET	922	979	1.131	1.131	1.199	1.199	
WR/W10/W11	1.001	1.063	1.228	1.228	1.302	1.302	
POCKET	62	77	62	62	77	77	
TIGER	70	86	70	70	86	86	
RELING	79	84	79	79	84	84	
RUGKUSSEN HOOG (75CM BREED)	33	33	33	33	33	33	
RUGKUSSEN HOOG(75CM BREED) M RASTOMAT	88	88	88	88	88	88	
Meerprijs	EUR	EUR	EUR	EUR	EUR	EUR	

NL PRIJSLIJST PAUL A							
Artikel code	1750U 1,75 UNTIEF	1750 1,75 TIEF	1751U 1,75AL UNTIEF	1753U 1,75AR UNTIEF	1751 1,75AL TIEF	1753 1,75AR TIEF	
OMSCHRIJVING	1,75 zits zonder armen, ondiep	1,75 zits zonder armen, diep	1,75 zits arm links, ondiep	1,75 zits arm rechts, ondiep	1,75 zits arm links, diep	1,75 zits arm rechts, diep	
BREEDTE (W)	120 cm	120 cm	147 cm	147 cm	147 cm	147 cm	
DIEPTE (L)	104 cm	120 cm	104 cm	104 cm	120 cm	120 cm	
HOOGTE (H)	79 cm	79 cm	79 cm	79 cm	79 cm	79 cm	
ZITHOOGTE (B) & ZITDIEPTE (C)	43 cm & 59 cm	43 cm & 74 cm	43 cm & 59 cm	43 cm & 59 cm	43 cm & 74 cm	43 cm & 74 cm	
QBM	0.8 qbm	0.92 qbm	0.98 qbm	0.98 qbm	1.13 qbm	1.13 qbm	
Stof	EUR	EUR	EUR	EUR	EUR	EUR	
2	543	581	638	638	678	678	
3	561	598	658	658	700	700	
4	598	640	706	706	748	748	
5	625	669	735	735	781	781	
6	642	689	757	757	801	801	
7	689	737	812	812	858	858	
8	737	792	869	869	920	920	
9	799	856	942	942	994	994	
Leer	EUR	EUR	EUR	EUR	EUR	EUR	
W1	869	924	1.058	1.058	1.115	1.115	
W2	900	955	1.098	1.098	1.159	1.159	
WM/W9/W12/RET	1.008	1.069	1.234	1.234	1.302	1.302	
WR/W10/W11	1.093	1.159	1.342	1.342	1.415	1.415	
POCKET	73	88	73	73	88	88	
TIGER	81	97	81	81	97	97	
RELING	84	88	84	84	88	88	
RUGKUSSEN HOOG (75CM BREED)	33	33	33	33	33	33	
RUGKUSSEN HOOG(75CM BREED) M RASTOMAT	88	88	88	88	88	88	
Meerprijs	EUR	EUR	EUR	EUR	EUR	EUR	

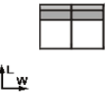
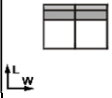
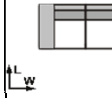
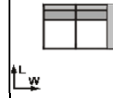
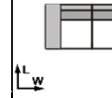
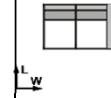
NL PRIJSLIJST PAUL A								
	Artikel code	2000U 2 UNTIEF	2000 2 TIEF	2001U 2AL UNTIEF	2003U 2AR UNTIEF	2001 2AL TIEF	2003 2AR TIEF	
OMSCHRIJVING	2 zits zonder armen, ondiep		2 zits zonder armen, diep		2 zits met arm links, ondiep		2 zits met arm rechts, ondiep	
BREEDTE (W)	160 cm	160 cm	187 cm	187 cm	187 cm	187 cm		
DIEPTE (L)	104 cm	120 cm	104 cm	104 cm	120 cm	120 cm		
HOOGTE (H)	79 cm	79 cm	79 cm	79 cm	79 cm	79 cm		
ZITHOOGTE (B) & ZITDIEPTE (C)	43 cm & 59 cm	43 cm & 74 cm	43 cm & 59 cm	43 cm & 59 cm	43 cm & 74 cm	43 cm & 74 cm		
OBM	1.06 qbm	1.22 qbm	1.24 qbm	1.24 qbm	1.43 qbm	1.43 qbm		
Stof	EUR	EUR	EUR	EUR	EUR	EUR		
2	724	766	823	823	869	869		
3	748	792	849	849	898	898		
4	801	843	906	906	959	959		
5	836	880	946	946	1.001	1.001		
6	860	904	975	975	1.030	1.030		
7	922	968	1.043	1.043	1.102	1.102		
8	988	1.036	1.118	1.118	1.181	1.181		
9	1.069	1.122	1.210	1.210	1.278	1.278		
Leer	EUR	EUR	EUR	EUR	EUR	EUR		
W1	1.217	1.291	1.397	1.397	1.472	1.472		
W2	1.263	1.340	1.448	1.448	1.518	1.518		
WM/W9/W12/RET	1.421	1.507	1.632	1.632	1.712	1.712		
WR/W10/W11	1.551	1.639	1.775	1.775	1.863	1.863		
POCKET	110	132	110	110	132	132		
TIGER	123	145	123	123	145	145		
RELING	92	97	92	92	97	97		
RUGKUSSEN HOOG (75CM BREED)	66	66	66	66	66	66		
RUGKUSSEN HOOG(75CM BREED) M RASTOMAT	176	176	176	176	176	176		
Meerprijs	EUR	EUR	EUR	EUR	EUR	EUR		

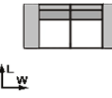
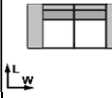
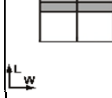
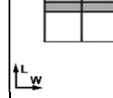
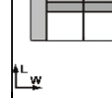
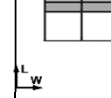
NL PRIJSLIJST PAUL A								
	Artikel code	2002U 2ALR UNTIEF	2002 2ALR TIEF	2500U 2,5 UNTIEF	2500 2,5 TIEF	2501U 2,5AL UNTIEF	2503U 2,5AR UNTIEF	
OMSCHRIJVING	2 zits met 2 armen, ondiep		2 zits met 2 armen, diep		2,5 zits zonder armen, ondiep		2,5 zits zonder armen, diep	
BREEDTE (W)	214 cm	214 cm	180 cm	180 cm	207 cm	207 cm		
DIEPTE (L)	104 cm	120 cm	104 cm	120 cm	104 cm	104 cm		
HOOGTE (H)	79 cm	79 cm	79 cm	79 cm	79 cm	79 cm		
ZITHOOGTE (B) & ZITDIEPTE (C)	43 cm & 59 cm	43 cm & 74 cm	43 cm & 59 cm	43 cm & 74 cm	43 cm & 59 cm	43 cm & 59 cm		
OBM	1.42 qbm	1.63 qbm	1.19 qbm	1.37 qbm	1.37 qbm	1.37 qbm		
Stof	EUR	EUR	EUR	EUR	EUR	EUR		
2	922	975	779	821	876	876		
3	953	1.005	805	847	904	904		
4	1.016	1.076	860	906	968	968		
5	1.060	1.124	900	944	1.012	1.012		
6	1.091	1.157	926	975	1.041	1.041		
7	1.168	1.241	994	1.043	1.115	1.115		
8	1.252	1.329	1.065	1.120	1.197	1.197		
9	1.355	1.439	1.157	1.212	1.296	1.296		
Leer	EUR	EUR	EUR	EUR	EUR	EUR		
W1	1.566	1.674	1.280	1.366	1.476	1.476		
W2	1.626	1.740	1.329	1.417	1.531	1.531		
WM/W9/W12/RET	1.828	1.962	1.492	1.595	1.723	1.723		
WR/W10/W11	1.991	2.145	1.624	1.738	1.877	1.877		
POCKET	110	110	132	154	132	132		
TIGER	123	123	145	167	145	145		
RELING	132	136	97	101	97	97		
RUGKUSSEN HOOG (75CM BREED)	66	66	66	66	66	66		
RUGKUSSEN HOOG(75CM BREED) M RASTOMAT	176	176	176	176	176	176		
Meerprijs	EUR	EUR	EUR	EUR	EUR	EUR		

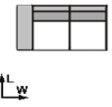
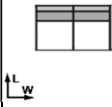
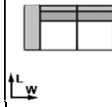
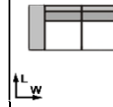
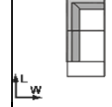
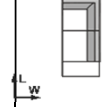
NL PRIJSLIJST PAUL A							
Artikel code	2501 2,5AL TIEF	2503 2,5AR TIEF	2502U 2,5ALR UNTIEF	2502 2,5ALR TIEF	6011U E1ABL UNTIEF	6013U E1ABR UNTIEF	
OMSCHRIJVING	2,5 zits met arm links, diep	2,5 zits met arm rechts, diep	2,5 zits met 2 armen, ondiep	2,5 zits met 2 armen, diep	Hoek met eiland links, ondiep	Hoek met eiland rechts, ondiep	
BREEDTE (W)	207 cm	207 cm	234 cm	234 cm	104 cm	104 cm	
DIEPTE (L)	120 cm	120 cm	104 cm	120 cm	239 cm	239 cm	
HOOGTE (H)	79 cm	79 cm	79 cm	79 cm	79 cm	79 cm	
ZITHOOGTE (B) & ZITDIEPTE (C)	43 cm & 74 cm	43 cm & 74 cm	43 cm & 59 cm	43 cm & 74 cm	43 cm & 59 cm	43 cm & 59 cm	
QBM	1.58 qbm	1.58 qbm	1.7 qbm	1.96 qbm	1.74 qbm	1.74 qbm	
Stof	EUR	EUR	EUR	EUR	EUR	EUR	
2	928	928	986	1.041	1.032	1.032	
3	959	959	1.016	1.074	1.065	1.065	
4	1.023	1.023	1.087	1.148	1.133	1.133	
5	1.069	1.069	1.135	1.197	1.177	1.177	
6	1.100	1.100	1.168	1.232	1.210	1.210	
7	1.179	1.179	1.252	1.320	1.289	1.289	
8	1.265	1.265	1.342	1.415	1.377	1.377	
9	1.368	1.368	1.452	1.531	1.483	1.483	
Leer	EUR	EUR	EUR	EUR	EUR	EUR	
W1	1.558	1.558	1.654	1.751	1.736	1.736	
W2	1.617	1.617	1.718	1.815	1.800	1.800	
WM/W9/W12/RET	1.819	1.819	1.932	2.046	2.022	2.022	
WR/W10/W11	1.982	1.982	2.101	2.226	2.198	2.198	
POCKET	154	154	132	154	165	165	
TIGER	167	167	145	167	178	178	
RELING	101	101	136	141	145	145	
RUGKUSSEN HOOG (75CM BREED)	66	66	66	66	99	99	
RUGKUSSEN HOOG(75CM BREED) M RASTOMAT	176	176	176	176	176	264	
Meerprijs	EUR	EUR	EUR	EUR	EUR	EUR	

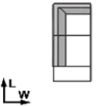
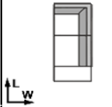
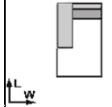
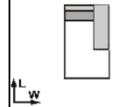
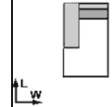
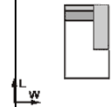
NL PRIJSLIJST PAUL A							
Artikel code	6011 E1ABL TIEF	6013 E1ABR TIEF	6151U LAL.KI UNTIEF	6153U LAR.KI UNTIEF	6151 LAL.KI TIEF	6153 LAR.KI TIEF	
OMSCHRIJVING	Hoek met eiland links, diep	Hoek met eiland rechts, diep	Longchair klein, arm links, ondiep	Longchair klein, arm rechts, ondiep	Longchair klein, arm links, diep	Longchair klein, arm rechts, diep	
BREEDTE (W)	120 cm	120 cm	107 cm	107 cm	107 cm	107 cm	
DIEPTE (L)	255 cm	255 cm	180 cm	180 cm	180 cm	180 cm	
HOOGTE (H)	79 cm	79 cm	79 cm	79 cm	79 cm	79 cm	
ZITHOOGTE (B) & ZITDIEPTE (C)	43 cm & 74 cm	43 cm & 74 cm	43 cm & 134 cm	43 cm & 134 cm	43 cm & 134 cm	43 cm & 134 cm	
QBM	2.13 qbm	2.13 qbm	1.23 qbm	1.23 qbm	1.23 qbm	1.23 qbm	
Stof	EUR	EUR	EUR	EUR	EUR	EUR	
2	1.129	1.129	832	832	847	847	
3	1.166	1.166	854	854	869	869	
4	1.239	1.239	898	898	913	913	
5	1.291	1.291	928	928	944	944	
6	1.327	1.327	948	948	966	966	
7	1.417	1.417	1.001	1.001	1.019	1.019	
8	1.511	1.511	1.056	1.056	1.076	1.076	
9	1.632	1.632	1.129	1.129	1.148	1.148	
Leer	EUR	EUR	EUR	EUR	EUR	EUR	
W1	1.907	1.907	1.298	1.298	1.309	1.309	
W2	1.976	1.976	1.340	1.340	1.353	1.353	
WM/W9/W12/RET	2.224	2.224	1.481	1.481	1.494	1.494	
WR/W10/W11	2.422	2.422	1.595	1.595	1.610	1.610	
POCKET	176	176	143	143	143	143	
TIGER	189	189	154	154	154	154	
RELING	154	154	92	92	92	92	
RUGKUSSEN HOOG (75CM BREED)	99	99	33	33	33	33	
RUGKUSSEN HOOG(75CM BREED) M RASTOMAT	264	264	88	88	88	88	
Meerprijs	EUR	EUR	EUR	EUR	EUR	EUR	

NL PRIJSLIJST PAUL A							
Artikel code		6061U LAL.Gr UNTIEF	6063U LAR.Gr UNTIEF	6061 LAL.Gr TIEF	6063 LAR.Gr TIEF	8020U Sp.KI UNTIEF	8020 Sp.KI TIEF
OMSCHRIJVING		Longchair arm links, groot, ondiep	Longchair arm rechts, groot, ondiep	Longchair arm links, groot, diep	Longchair arm rechts, groot, diep	Hoeelement klein, ondiep	Hoeelement klein, diep
BREEDTE (W)		127 cm	127 cm	127 cm	127 cm	104 cm	120 cm
DIEPTE (L)		180 cm	180 cm	180 cm	180 cm	104 cm	120 cm
HOOGTE (H)		79 cm	79 cm	79 cm	79 cm	79 cm	79 cm
ZITHOOGTE (B) & ZITDIEPTE (C)		43 cm & 134 cm	43 cm & 134 cm	43 cm & 134 cm	43 cm & 134 cm	43 cm & 59 cm	43 cm & 74 cm
QBM		1.45 qbm	1.45 qbm	1.45 qbm	1.45 qbm	0.7 qbm	0.92 qbm
Stof	EUR	EUR	EUR	EUR	EUR	EUR	EUR
2	891	891	906	906	576	638	
3	915	915	931	931	594	658	
4	964	964	981	981	634	706	
5	1.001	1.001	1.019	1.019	660	737	
6	1.025	1.025	1.043	1.043	682	759	
7	1.085	1.085	1.104	1.104	728	814	
8	1.151	1.151	1.170	1.170	781	873	
9	1.230	1.230	1.252	1.252	843	948	
Leer	EUR	EUR	EUR	EUR	EUR	EUR	
W1	1.395	1.395	1.415	1.415	1.019	1.091	
W2	1.441	1.441	1.461	1.461	1.056	1.135	
WM/W9/W12/RET	1.599	1.599	1.621	1.621	1.197	1.280	
WR/W10/W11	1.725	1.725	1.747	1.747	1.305	1.395	
POCKET	147	147	147	147	62	88	
TIGER	158	158	158	158	70	97	
RELING	101	101	101	101	66	70	
RUGKUSSEN HOOG (75CM BREED)	33	33	33	33	66	66	
RUGKUSSEN HOOG(75CM BREED) M RASTOMAT	88	88	88	88	176	176	
Meerprijs	EUR	EUR	EUR	EUR	EUR	EUR	

NL PRIJSLIJST PAUL A							
Artikel code		908080 Hocker 80x80	901010 Hocker 100x100	901210 Hocker 120x100	7010410 Zwischenhocker 104x100	701210 Zwischenhocker 120x100	902370 Kopfstutze 70 m.Rastomat
OMSCHRIJVING		Hocker 80x80	Pouf 100x100	Pouf 120x100	Tussenhocker 104x100 (diepte 104)	Tussenhocker 120x100 (diepte 120)	Hoofdsteun breedte 70 cm verstelbaar
BREEDTE (W)		80 cm	100 cm	100 cm	100 cm	100 cm	74 cm
DIEPTE (L)		80 cm	100 cm	120 cm	104 cm	120 cm	62 cm
HOOGTE (H)		43 cm	43 cm	43 cm	43 cm	43 cm	20 cm
ZITHOOGTE (B) & ZITDIEPTE (C)		43 cm & 80 cm	43 cm & 100 cm	43 cm & 120 cm	43 cm & 104 cm	43 cm & 120 cm	cm & cm
QBM		0.3 qbm	0.46 qbm	0.54 qbm	0.47 qbm	0.54 qbm	0.24 qbm
Stof	EUR	EUR	EUR	EUR	EUR	EUR	EUR
2	310	359	387	365	387	114	
3	317	370	398	376	398	117	
4	334	389	420	398	420	121	
5	345	405	436	411	436	128	
6	352	416	447	422	447	130	
7	372	440	473	447	473	136	
8	392	466	502	473	499	141	
9	416	499	537	506	535	150	
Leer	EUR	EUR	EUR	EUR	EUR	EUR	
W1	438	530	583	543	583	161	
W2	451	548	601	561	601	167	
WM/W9/W12/RET	493	605	669	618	667	174	
WR/W10/W11	528	651	719	667	717	178	
POCKET	62	79	88	62	88		
TIGER	66	86	97	86	97		
RELING	106	114	123	35	40		
RUGKUSSEN HOOG (75CM BREED)							
RUGKUSSEN HOOG(75CM BREED) M RASTOMAT							
Meerprijs	EUR	EUR	EUR	EUR	EUR	EUR	

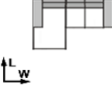
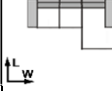
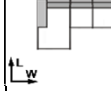
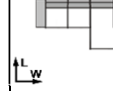
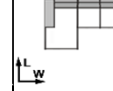
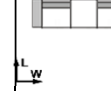
NL PRIJSLIJST PAUL A						
Artikel code	645	649U	647U	649	647	9455U
OMSCHRIJVING	LAL.Gr TIEF-2AR TIEF	2,5AL UNTIEF-LAR.Gr UNTIEF	LAL.Gr UNTIEF-2,5AR UNTIEF	2,5AL TIEF-LAR.Gr TIEF	LAL.Gr TIEF-2,5AR TIEF	1,5AL UNTIEF-Zwischenhocker 104x100-1,5AR UNTIEF
	Longchair arm links, groot + 2 zits arm rechts, diep	2,5 zits arm links + longchair arm rechts, groot; ondiep	Longchair arm links, groot + 2,5 zits arm rechts, ondiep	2,5 zits arm links + longchair arm rechts, groot; diep	Longchair arm links, groot + 2,5 zits arm rechts, diep	1,5 zits met arm links + Tussenhocker 104x100 + 1,5 zits met arm rechts; ondiep
BREEDTE (W)	315 cm	335 cm	335 cm	335 cm	335 cm	356 cm
DIEPTE (L)	180 cm	180 cm	180 cm	180 cm	180 cm	104 cm
HOOGTE (H)	79 cm	79 cm	79 cm	79 cm	79 cm	79 cm
ZITHOOGTE (B) & ZITDIEPTE (C)	43 cm & 74 cm	43 cm & 59 cm	43 cm & 59 cm	43 cm & 74 cm	43 cm & 74 cm	43 cm & 59 cm
QBM	2.88 qbm	2.82 qbm	2.82 qbm	3.03 qbm	3.03 qbm	2.17 qbm
Stof	EUR	EUR	EUR	EUR	EUR	EUR
2	1.775	1.767	1.767	1.835	1.835	1.549
3	1.828	1.819	1.819	1.890	1.890	1.599
4	1.940	1.932	1.932	2.004	2.004	1.701
5	2.020	2.013	2.013	2.088	2.088	1.771
6	2.072	2.066	2.066	2.143	2.143	1.822
7	2.207	2.200	2.200	2.284	2.284	1.943
8	2.352	2.347	2.347	2.435	2.435	2.075
9	2.530	2.526	2.526	2.620	2.620	2.235
Leer	EUR	EUR	EUR	EUR	EUR	EUR
W1	2.886	2.871	2.871	2.972	2.972	2.488
W2	2.979	2.972	2.972	3.078	3.078	2.576
WM/W9/W12/RET	3.333	3.322	3.322	3.441	3.441	2.880
WR/W10/W11	3.610	3.601	3.601	3.729	3.729	3.122
POCKET	279	279	279	301	301	185
TIGER	304	304	304	326	326	227
RELING	198	198	198	202	202	194
RUGKUSSEN HOOG (75CM BREED)	99	99	99	99	99	66
RUGKUSSEN HOOG(75CM BREED) M RASTOMAT	264	264	264	264	264	176
Meerprijs	EUR	EUR	EUR	EUR	EUR	EUR

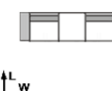
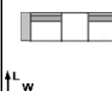
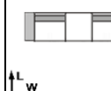
NL PRIJSLIJST PAUL A			
Artikel code	9455	9456U	9456
OMSCHRIJVING	1,5AL TIEF-Zwischenhocker 120x100-1,5AR TIEF	1,75AL UNTIEF-Zw.Hocker 104x100-1,75AR UNTIEF	1,75AL TIEF-Zw.Hocker 120x100-1,75AR TIEF
	1,5 zits met arm links + Tussenhocker 120x100 + 1,5 zits met arm rechts; diep	1,75 zits met arm links + Tussenhocker 104x100 + 1,75 zits met arm rechts; ondiep	1,75 zits met arm links + Tussenhocker 120x100 + 1,75 zits met arm rechts; diep
BREEDTE (W)	356 cm	396 cm	396 cm
DIEPTE (L)	120 cm	104 cm	120 cm
HOOGTE (H)	79 cm	79 cm	79 cm
ZITHOOGTE (B) & ZITDIEPTE (C)	43 cm & 74 cm	43 cm & 59 cm	43 cm & 74 cm
QBM	2.5 qbm	2.43 qbm	2.8 qbm
Stof	EUR	EUR	EUR
2	1.641	1.641	1.742
3	1.692	1.692	1.797
4	1.802	1.811	1.916
5	1.870	1.881	1.998
6	1.925	1.936	2.048
7	2.053	2.070	2.189
8	2.189	2.211	2.339
9	2.356	2.389	2.523
Leer	EUR	EUR	EUR
W1	2.647	2.660	2.814
W2	2.739	2.757	2.919
WM/W9/W12/RET	3.065	3.087	3.271
WR/W10/W11	3.322	3.351	3.546
POCKET	242	207	264
TIGER	268	249	290
RELING	207	202	216
RUGKUSSEN HOOG (75CM BREED)	66	66	66
RUGKUSSEN HOOG(75CM BREED) M RASTOMAT	176	176	176
Meerprijs	EUR	EUR	EUR